

# Living Architecture Exploration Kits: Introductory Assemblies

Living Architecture Systems Group

This folio describes introductory assemblies that can be created by using a series of exploration kits that have been developed by the Living Architecture Systems Group. An accompanying volume entitled Living Architecture Kits: Component Catalogue provides detailed documentation of component patterns and individual device assemblies contained within the kit series.

These kits encourage experimentation with interactive architectural constructions, supporting design of combinations of individual components within multiple distributed arrays. The physical kit components that have been included within this construction system are part of an evolving collection of tools and component designs that have been developed by the Living Architecture Systems Group under Creative Commons licensing.

Creative Commons open-source licensing permits non-commercial adaptation and extension of the patterns illustrated here.

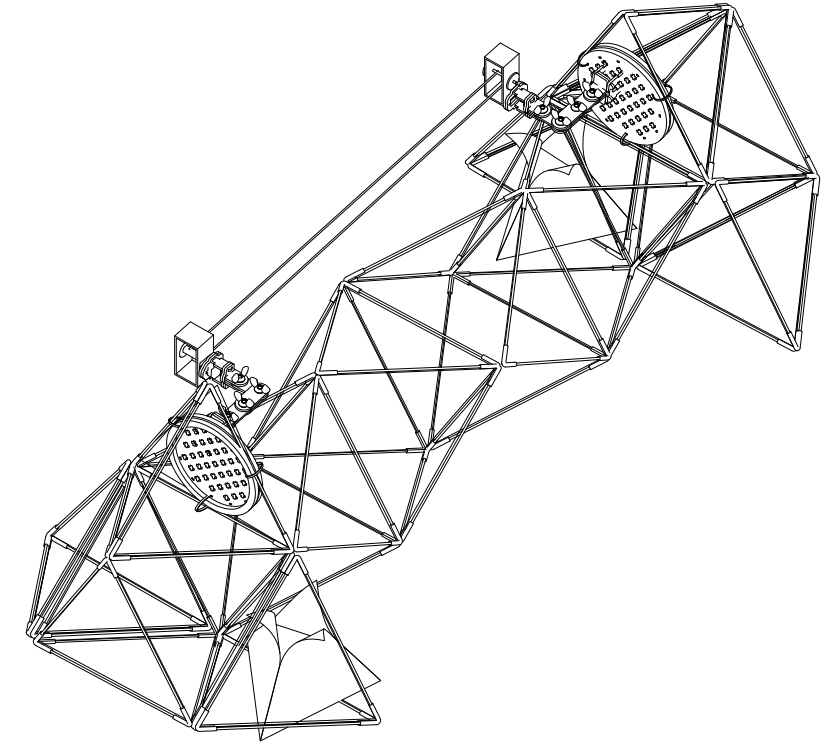

# Living Architecture Exploration Kits

INTRODUCTORY ASSEMBLIES

PHILIP BEESLEY, MICHAEL LANCASTER  
& LIVING ARCHITECTURE SYSTEMS GROUP

ISBN 978-1-988366-55-5



9 781988 366555

Riverside Architectural Press



LASG

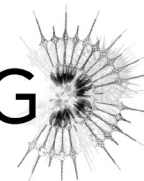

Living Architecture  
Exploration Kits  
*Introductory Assemblies*

Philip Beesley, Michael Lancaster  
& Living Architecture Systems Group



LASG

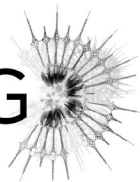

Publisher: Riverside Architectural Press  
www.riversidearchitecturalpress.ca

© 2022 Living Architecture Systems Group and Riverside Architectural Press.  
All rights reserved.

Title: Living Architecture Exploration Kits: Introductory Assemblies  
Names: Beesley, Philip, 1956-author. | Lancaster, Michael, 1995-author. |  
Chiu, Adrian, 1996-editor | Lu, Glenn, 2000-editor. | Weeko Martin, Bianca,  
1996-editor. | Living Architecture Systems Group, issuing body.

Description: Series statement: Living Architecture Systems Group folio series..

Identifiers: ISBN 978-1-988366-55-5

Publication: December 2022  
Riverside Architectural Press  
7 Melville Street  
Cambridge, Ontario, N1S 2H4  
Canada

Design and Production by Living Architecture Systems Group

The individual authors shown herein are solely responsible for their content  
appearing within this publication.

The physical and digital works referenced within this folio are copyright of  
Philip Beesley Studio Inc. / Living Architecture Systems Group and may not be  
reproduced without the express consent of the copyright holder.

Errors or omissions will be corrected in subsequent editions.  
This book is set in Garamond and Zurich BT.



Social Sciences and Humanities  
Research Council of Canada

Conseil de recherches en  
sciences humaines du Canada

## About the Living Architecture Systems Group

The publication forms part of a series of work-in-progress reports and publications by Living Architecture researchers and contributors. The Living Architecture Systems Group is an international partnership of researchers, artists, and industrial collaborators studying how we can build living architectural systems— sustainable, adaptive environments that can move, respond, and learn, and that are inclusive and empathic toward their inhabitants. “Smart” responsive architecture is rapidly transforming our built environments, but it is fraught with problems including sustainability, data privacy, and privatized infrastructure. These concerns need conceptual and technical analysis so that designers, urban developers and architects can work positively within this deeply influential new field.<sup>1</sup> The Living Architecture Systems Group is developing tools and conceptual frameworks for examining materials, forms, and topologies, seeking sustainable, flexible, and durable working models of living architecture.

A series of far-reaching critical questions can be explored by using the tools and frameworks that are described within this specialized publication series: can the buildings that we live in come alive? Could living buildings create a sustainable future with adaptive structures while empathizing and inspiring us? These questions can help redefine architecture with new, lightweight physical structures, embedded sentient and responsive systems, and mutual relationships for occupant that provide tools and frameworks to support the emerging field of living architecture. The objective of this integrated work envisions embodied environments that can provide tangible examples in order to shift architecture away from static and inflexible forms towards spaces that can move, respond, learn, and exchange,<sup>2</sup> becoming adaptive and empathic toward their inhabitants.<sup>3</sup>

1 Kas Oosterhuis and Xin Xia, *iA #1, Interactive Architecture* (Rotterdam: Episode Publishers, 2007); Nicholas Negroponte, *Being Digital* (New York: Vintage Books, 1995); Lucy Bullivant, *4dsocial: Interactive Design Environments* (London: AD/John Wiley & Sons, 2007); Neil Spiller, *Digital Architecture Now: A Global Survey of Emerging Talent* (London: Thames & Hudson, 2009). Michael Fox and Miles Kemp, *Interactive Architecture* (Princeton: Princeton Architectural Press, 2009).

2 For example the Living Architecture (LIAR) next-generation, selectively programmable bioreactor developed by LASG Metabolism Stream Lead Rachel Armstrong, Newcastle, uses microbial processes to generate electricity, oxygen, fertiliser, and other life-sustaining outputs from waste (carbon dioxide, grey water) that would otherwise be ejected from a building: “Living Architecture LIAR,” accessed February 2, 2022, <https://livingarchitecture-h2020.eu/>.

3 Bullivant, *4dsocial*.

# Contents

1	Introduction
3	Interactive Soundscape
9	Sound and Shadow Performance
11	Light Group
15	Motion Group
17	Sound Group
19	Interactive Arrays Exploration
26	References
27	Open Access LASG Publications
29	Credits

# Introduction

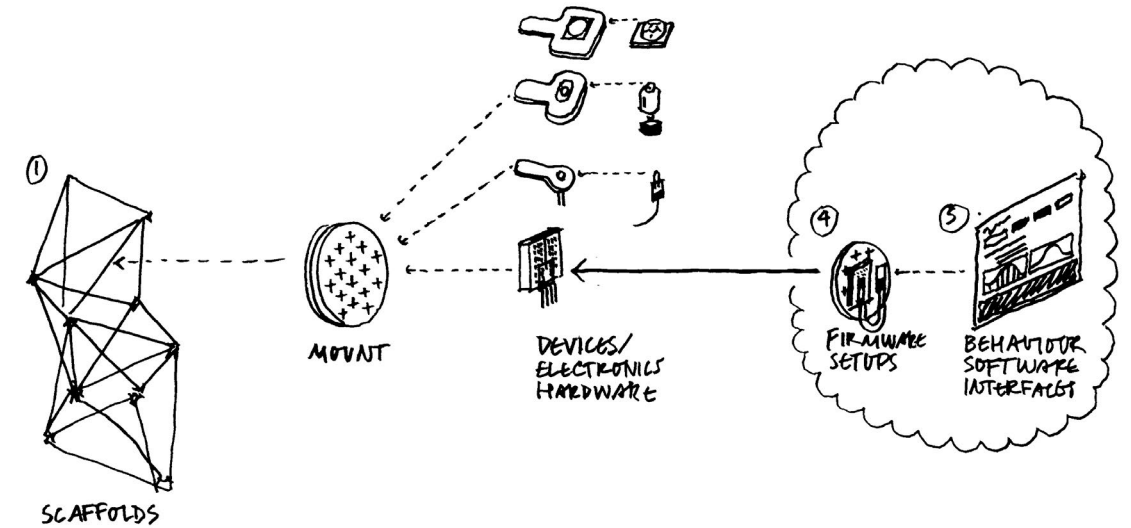

above

Smart Cell System conceptual integration diagram, LASG/PBSI

This folio describes introductory assemblies that can be created by using a series of exploration kits that have been developed by the Living Architecture Systems Group. An accompanying volume entitled Living Architecture Kits: Component Catalogue provides detailed documentation of component patterns and individual device assemblies contained within the kit series.

These kits encourage experimentation with interactive architectural constructions, supporting design of combinations of individual components within multiple distributed arrays. The physical kit components that have been included within this construction system are part of an evolving collection of tools and component designs that have been developed by the Living Architecture Systems Group under Creative Commons licensing.

Creative Commons open-source licensing permits non-commercial adaptation and extension of the patterns illustrated here.





# Interactive Soundscapes

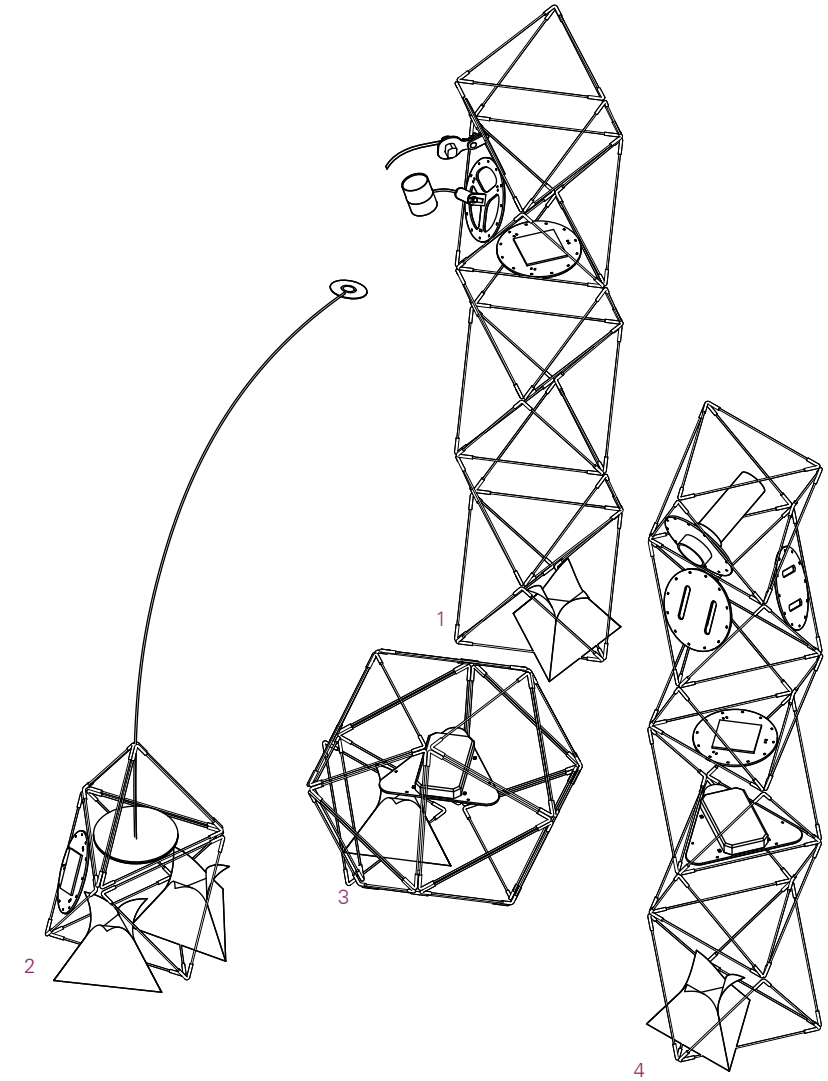

## Soundscape Group Assembly Types

- 1 Drumming Tower Assembly
- 2 Antenna Assembly
- 3 Power Node Assembly
- 4 Sound Tower Assembly



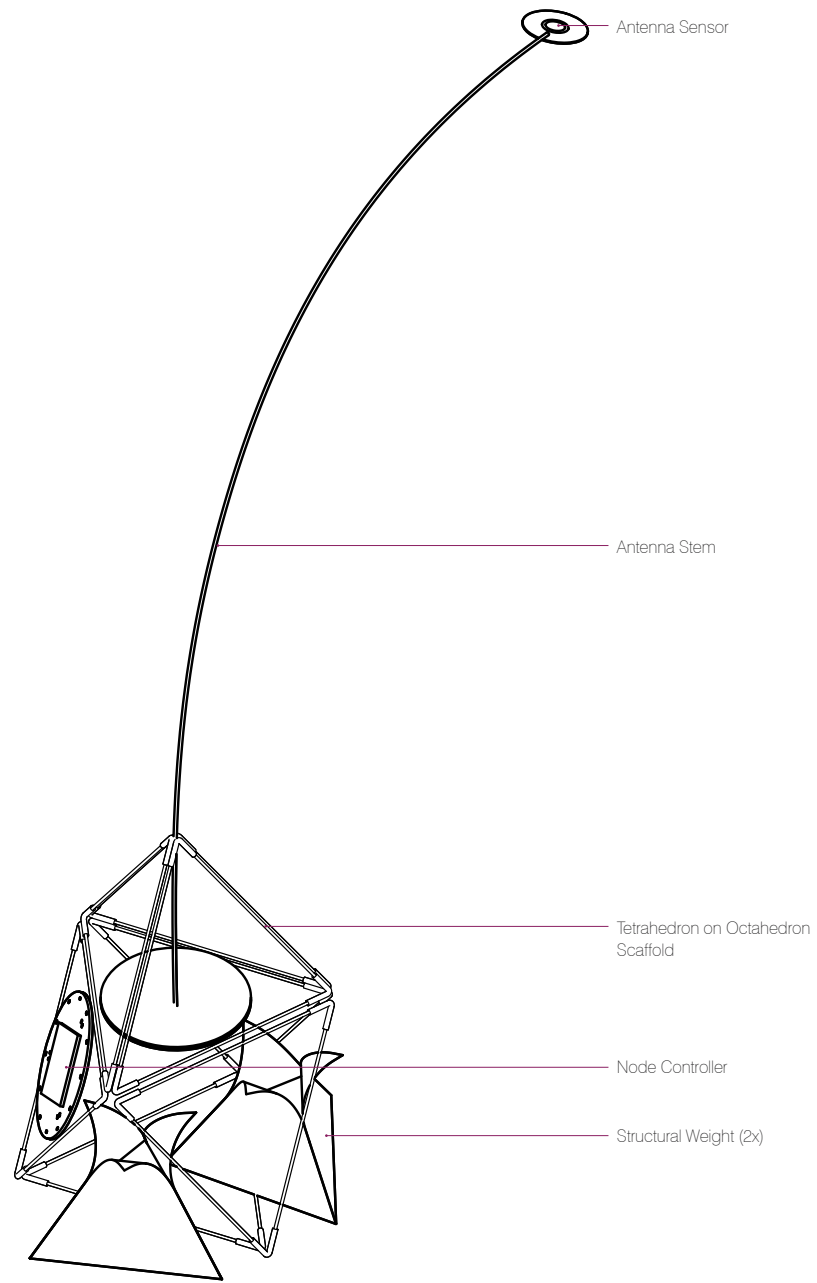

Antenna Assembly

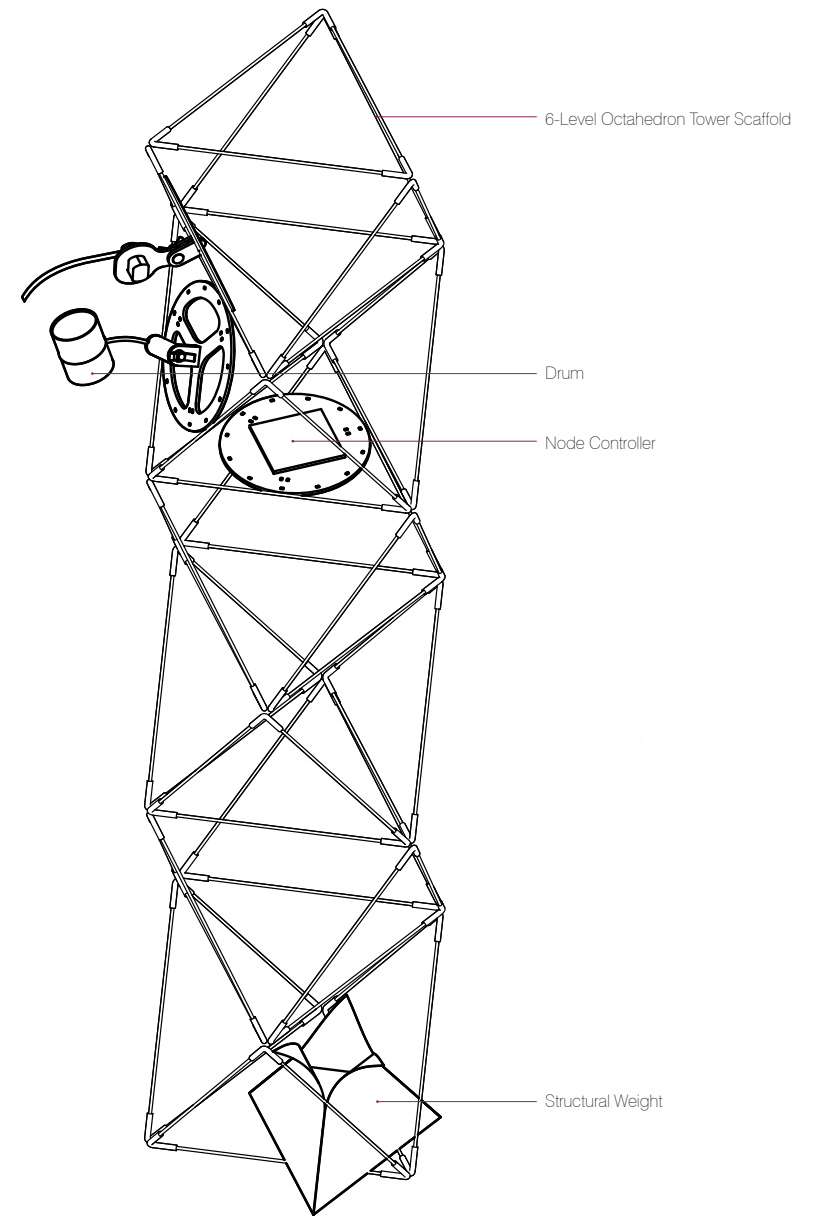

Drum Tower Assembly

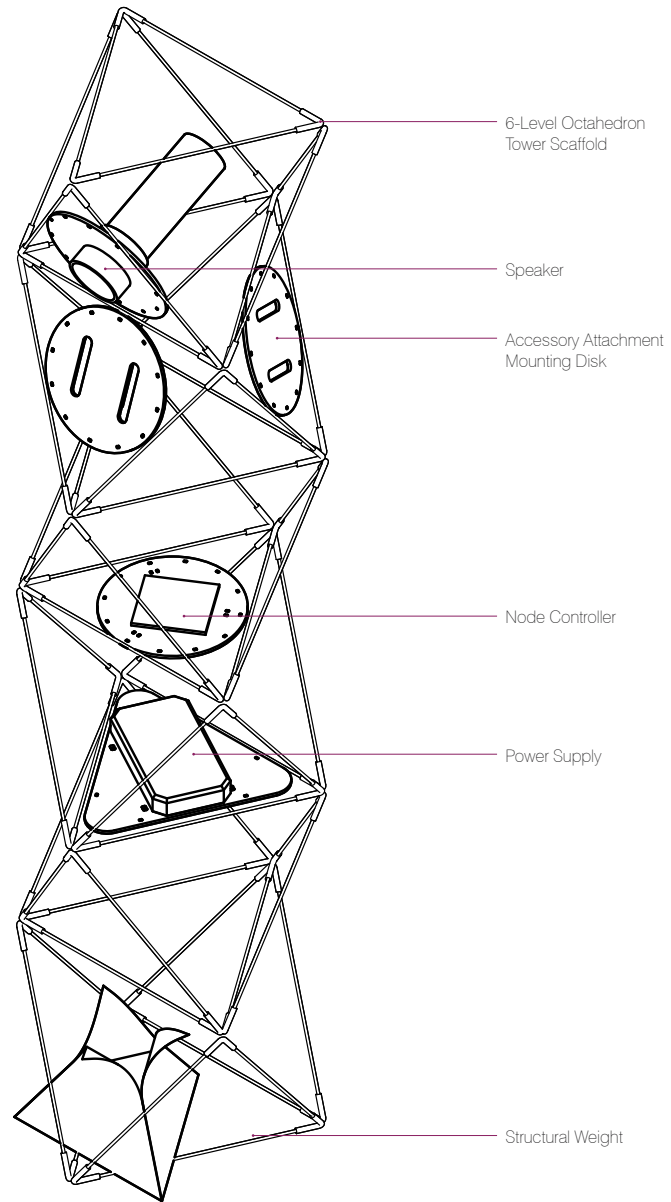

Sound Tower Assembly

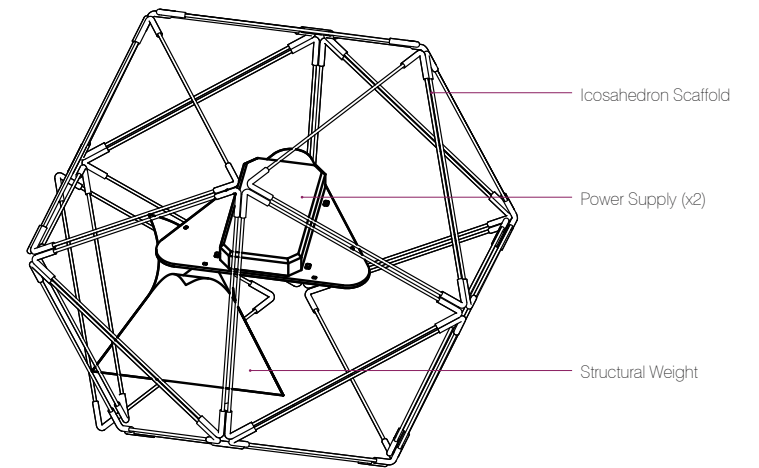

Power Node Assembly



# Sound and Shadow Performance

## Light Group

- 1 Electronics Assembly Type A
- 2 Flashlight Assembly (x2)
- 3 Turntable Assembly
- 4 Crystal Assembly
- 5 Projector Screen Assembly

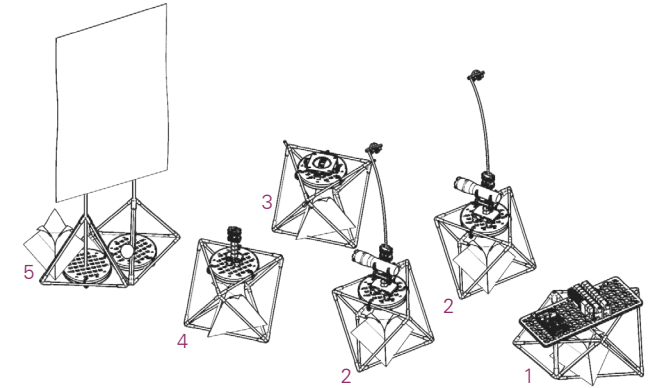

## Motion Group

- 1 Electronics Assembly Type A
- 2 Shape on Servo Assembly
- 3 Blade of Grass Assembly
- 4 Clothesline Assembly

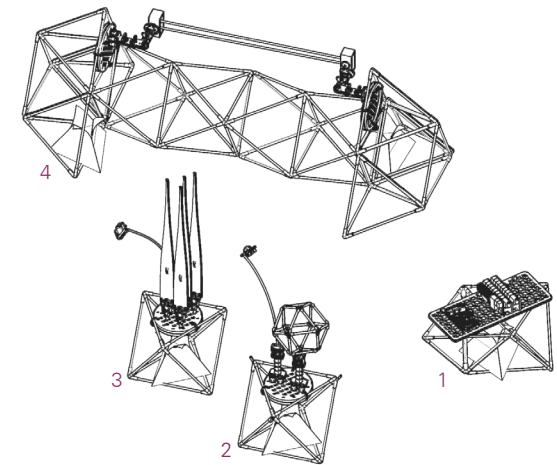

## Sound Group

- 1 Electronics Assembly Type B
- 2 Rotating Clicker Assembly (x2)
- 3 Sound Sampler WAV Assembly
- 4 Voice Recorder Assembly

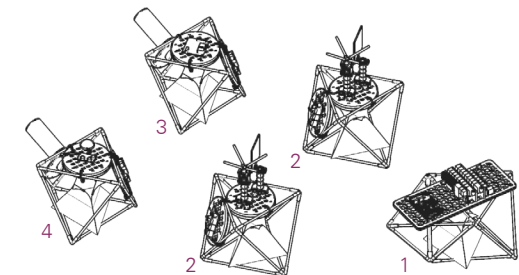



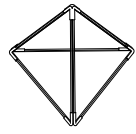

Scaffold Type A

Pyramid Unit

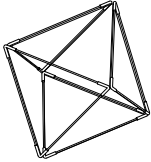

Scaffold Type B

Octahedron Unit

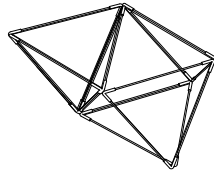

Scaffold Type C

Octahedron with Pyramid Extension

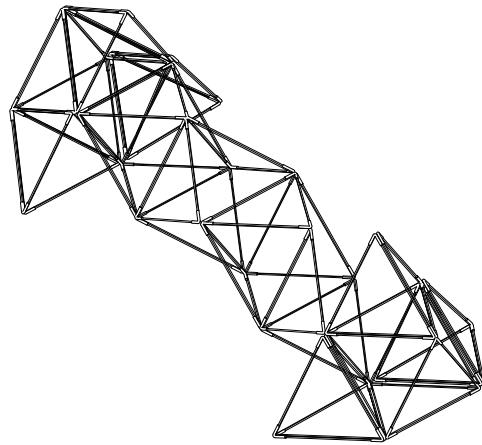

Scaffold Type D

Space Truss Tower with Stabilizing Sleds

### Assembly Scaffold Types

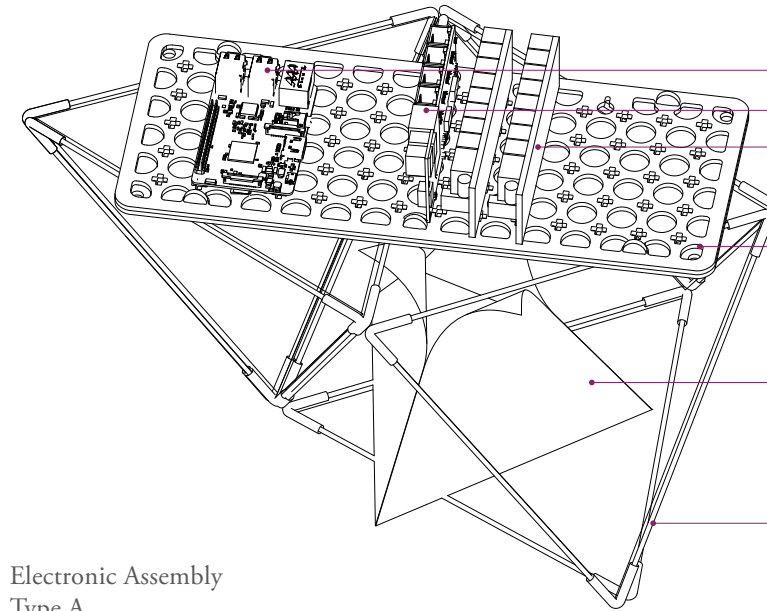

- Raspberry Pi
- Node Controller
- High Current Device Module (HCDM) (x2)
- Acrylic Mounting Tray
- Structural Weight
- Scaffold Type C

Electronic Assembly Type A

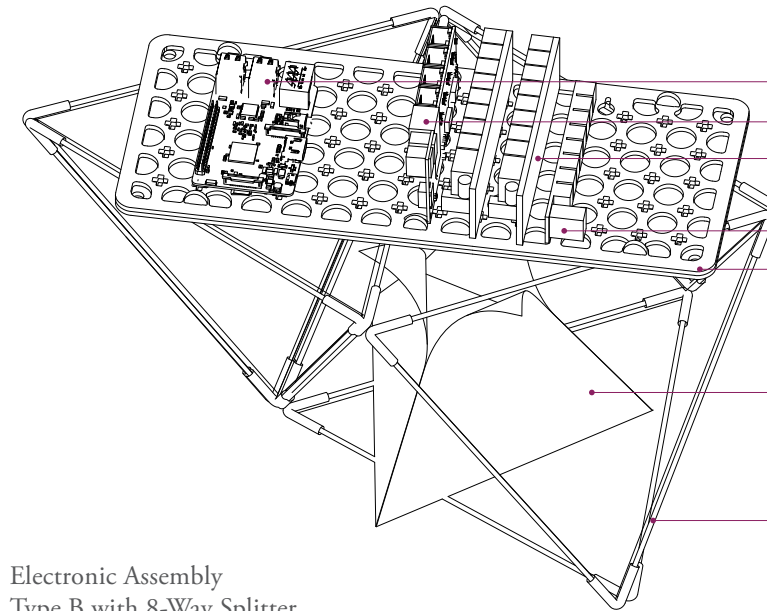

- Raspberry Pi
- Node Controller
- High Current Device Module (HCDM) (x2)
- 8-way Splitter
- Acrylic Mounting Tray
- Structural Weight
- Scaffold Type C

Electronic Assembly Type B with 8-Way Splitter

### Electronics Assembly Types

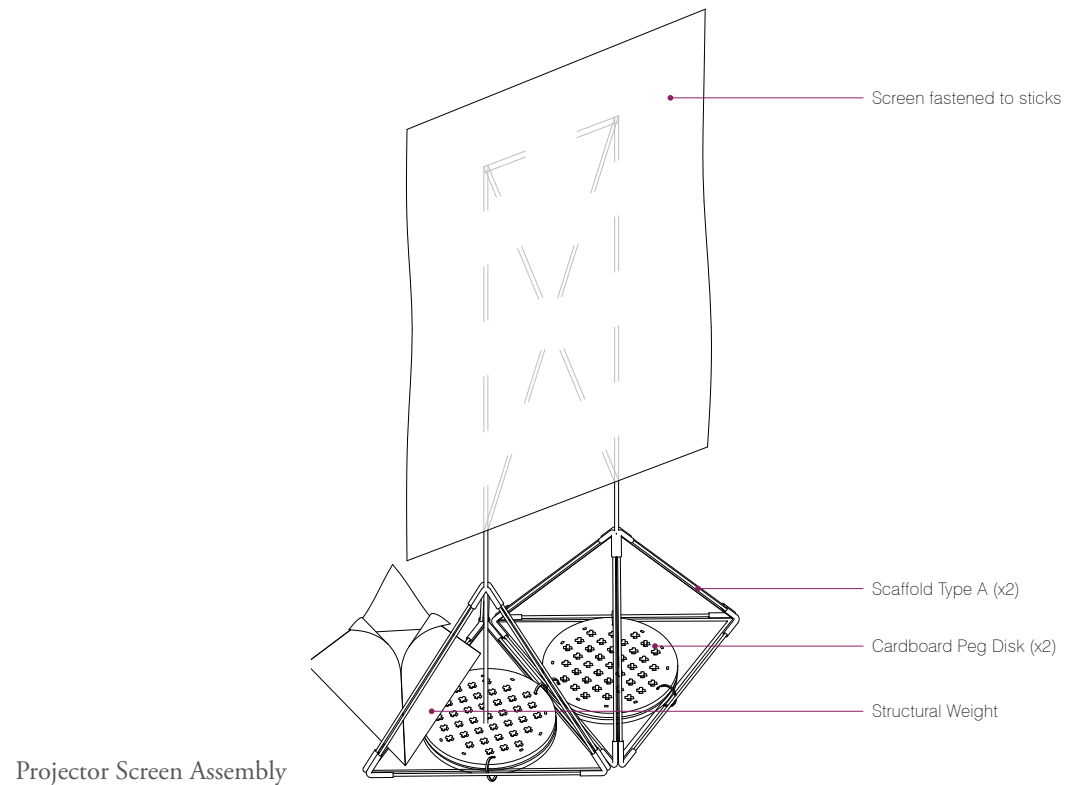

Projector Screen Assembly

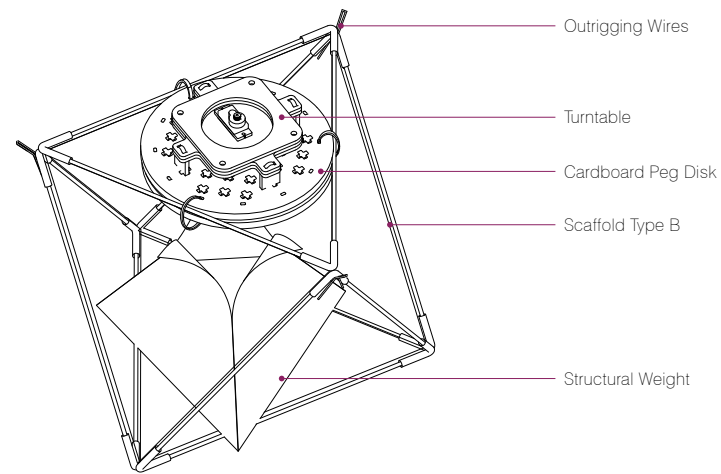

Turntable Assembly

## Light Group Assemblies

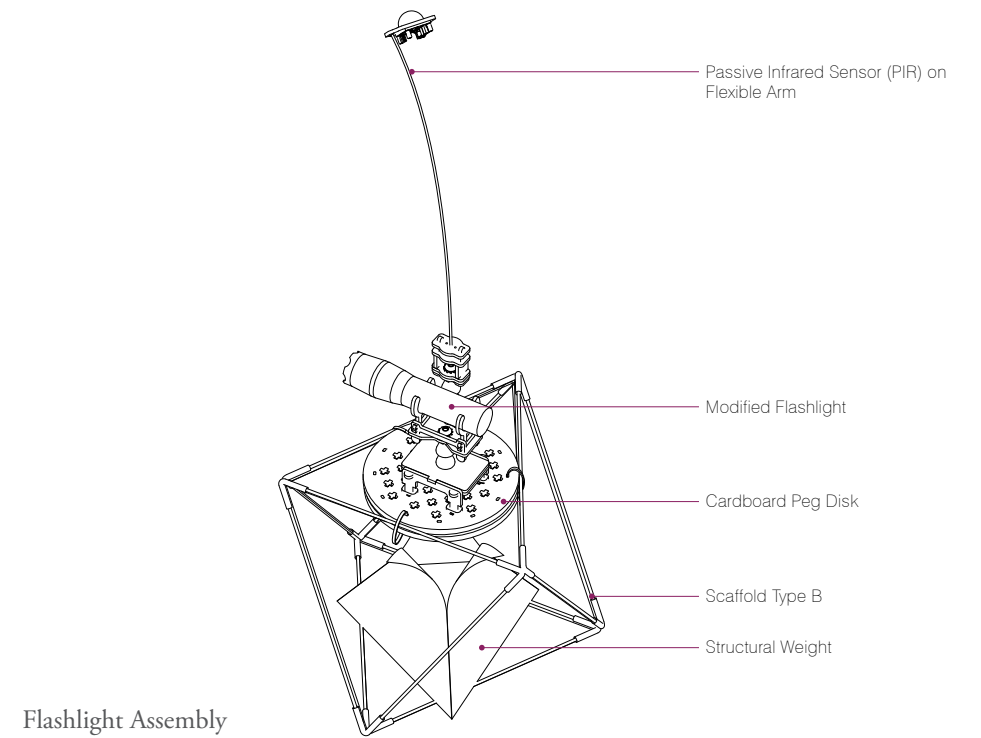

Flashlight Assembly

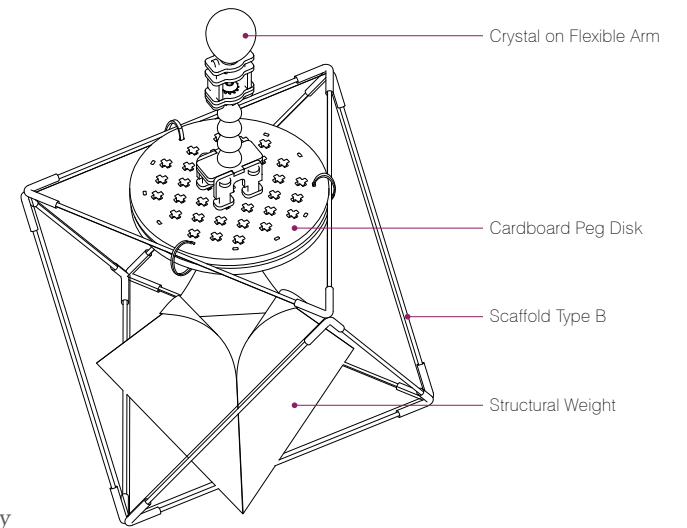

Crystal Assembly

## Light Group Assemblies

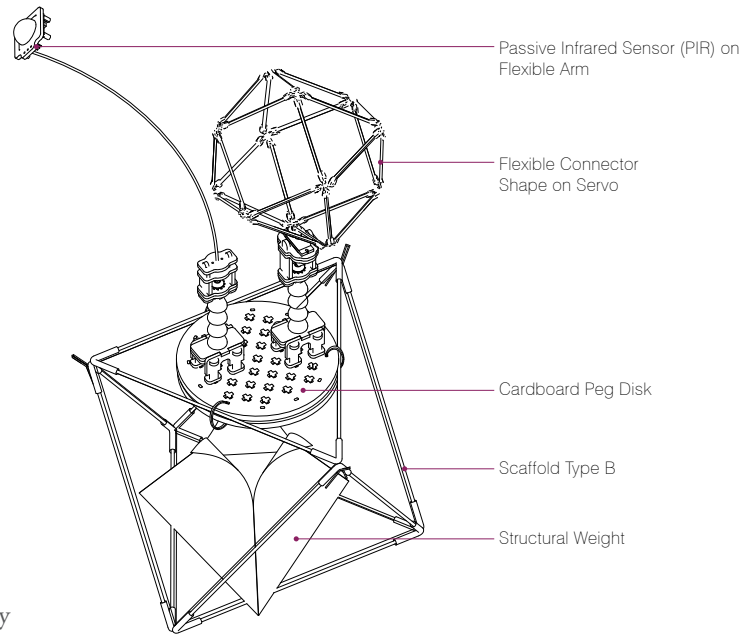

Shape on Servo Assembly

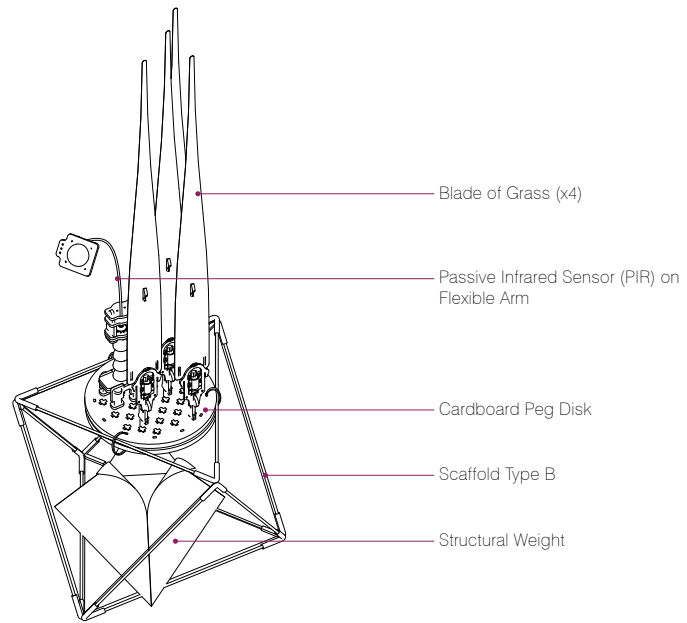

Blade of Grass Assembly

## Motion Group Assemblies

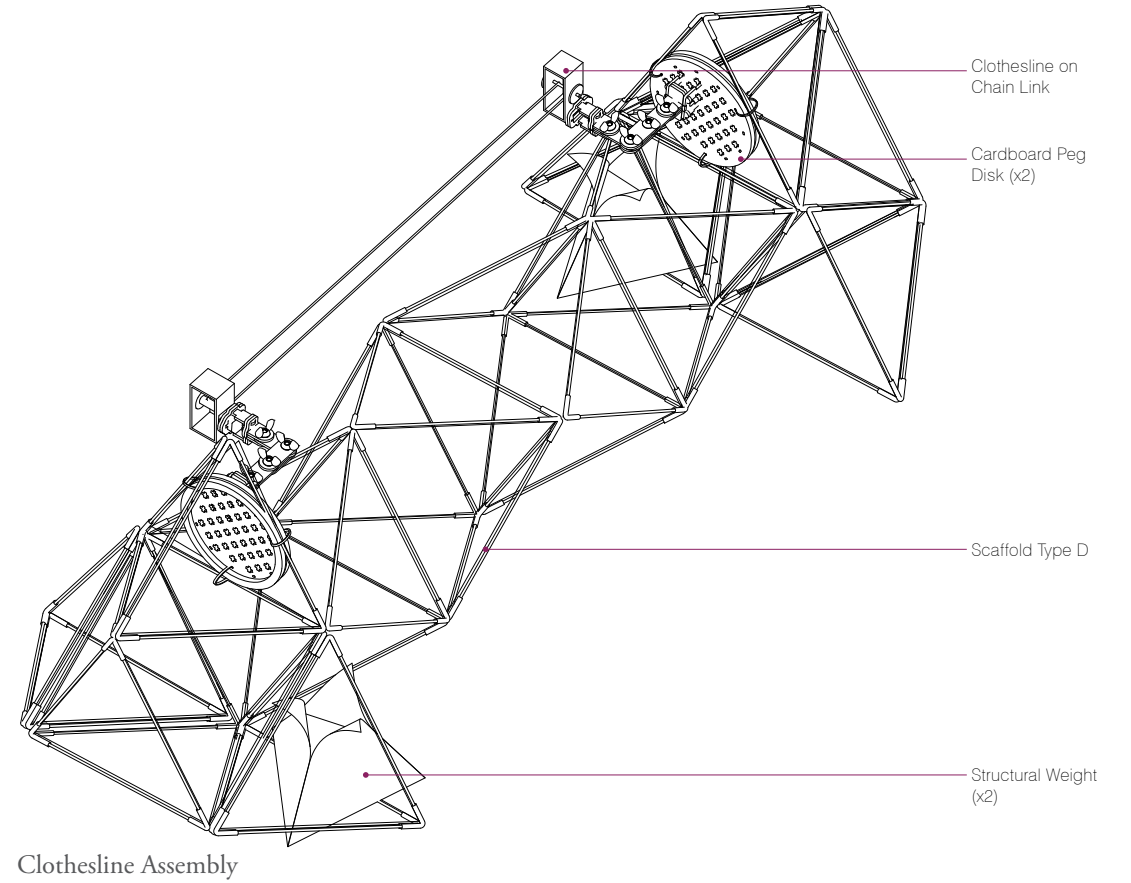

Clothesline Assembly

## Motion Group Assemblies



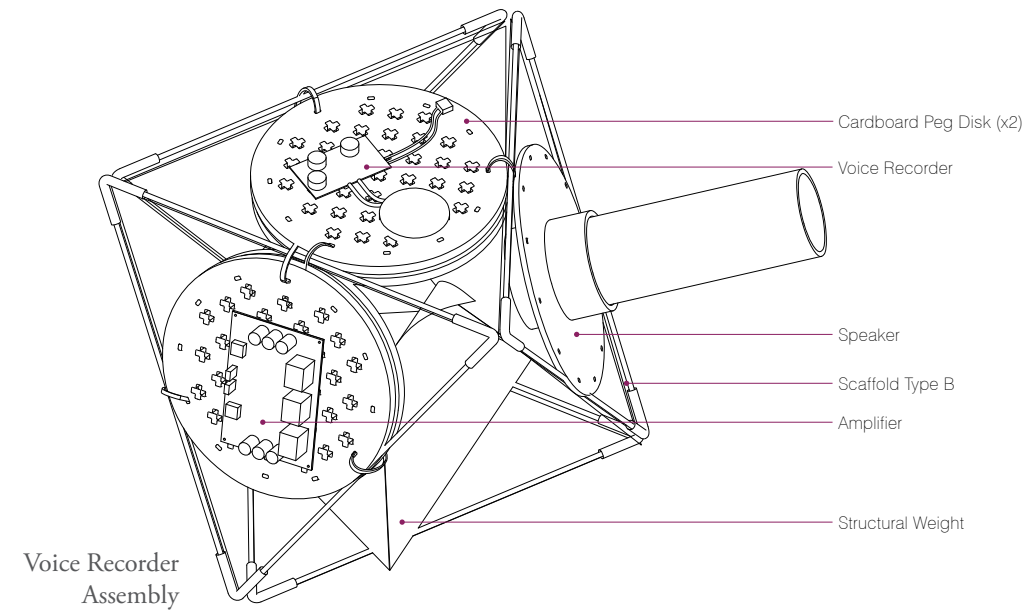
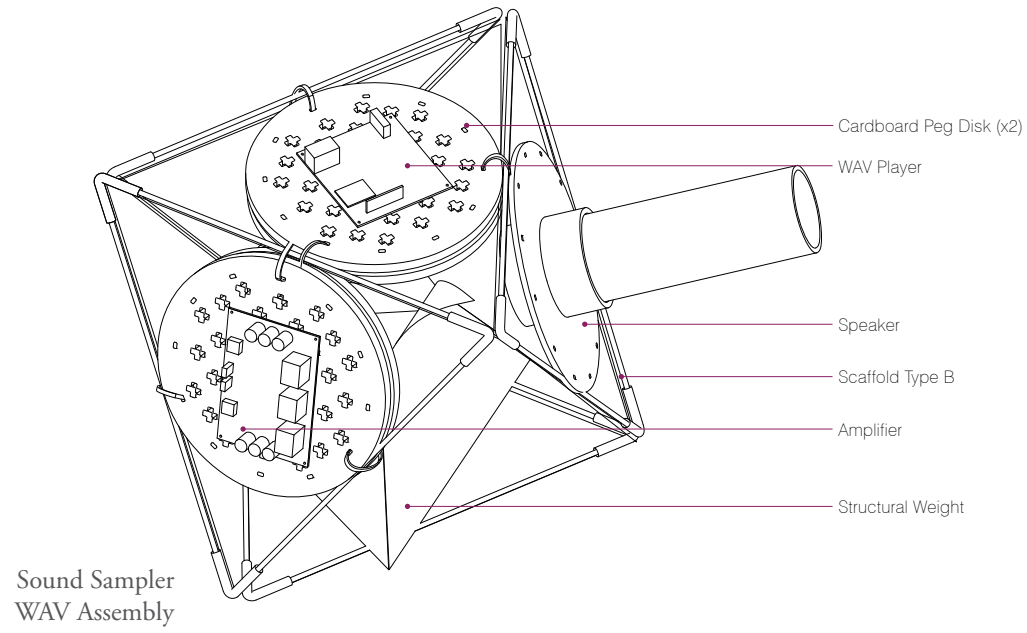

### Sound Group Assemblies

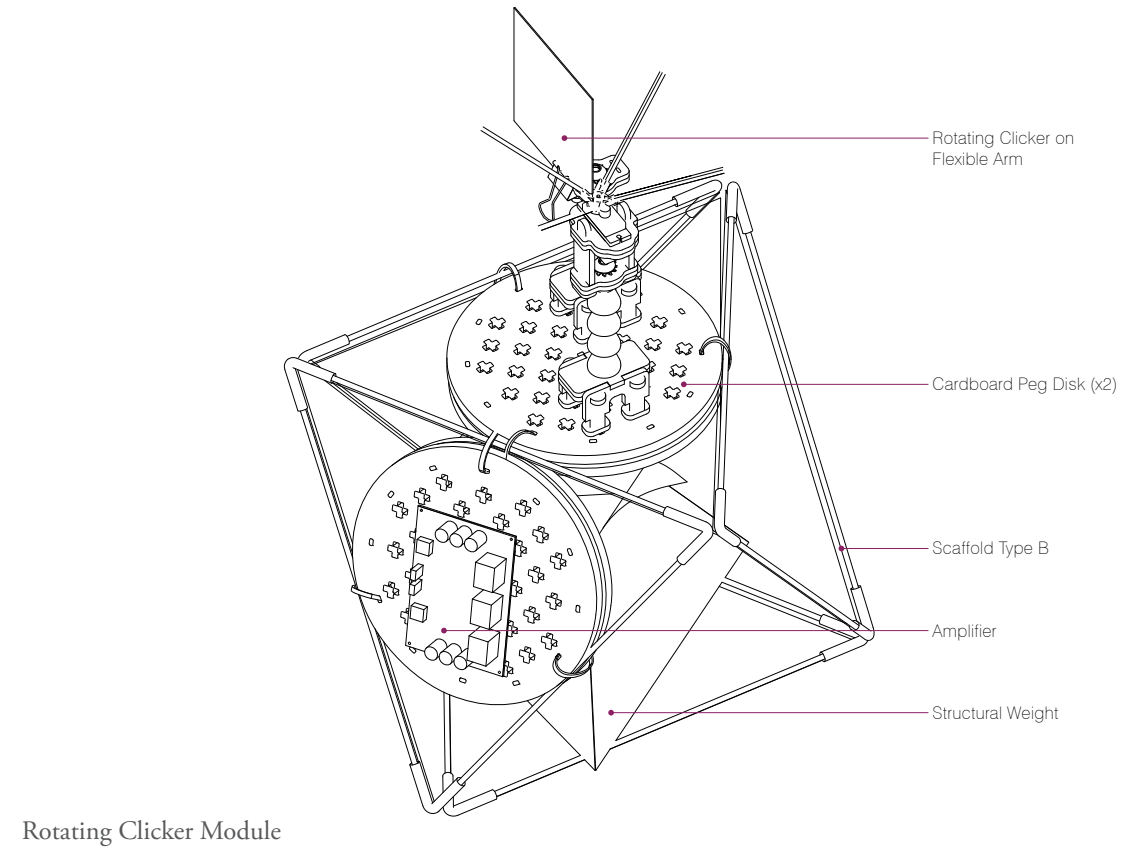

### Sound Group Assemblies

# Interactive Array Exploration

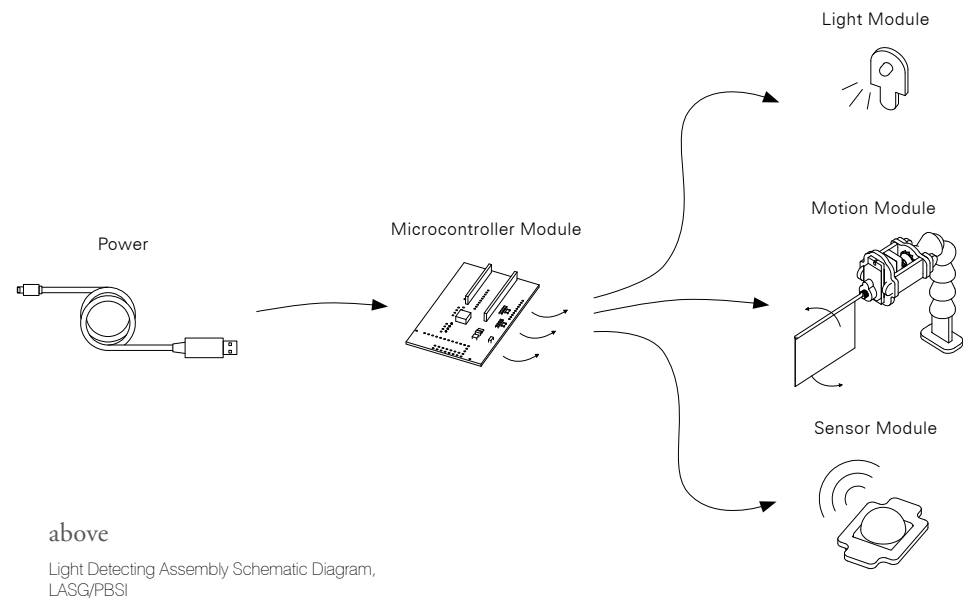

## Light Detecting Assembly

- 1 Node Controller Module
- 2 Rotating Arm Module
- 3 Light Module
- 4 Light Sensor Module

## Variation: Motion Detecting Assembly

- 5 Change Light Module into an Empty Module by Taking Out the Indicator LED
- 6 Change Light Sensor Module with Motion Sensor Module by Replacing Photoresistor with PIR Sensor
- a PIR Sensor
- b Indicator LED

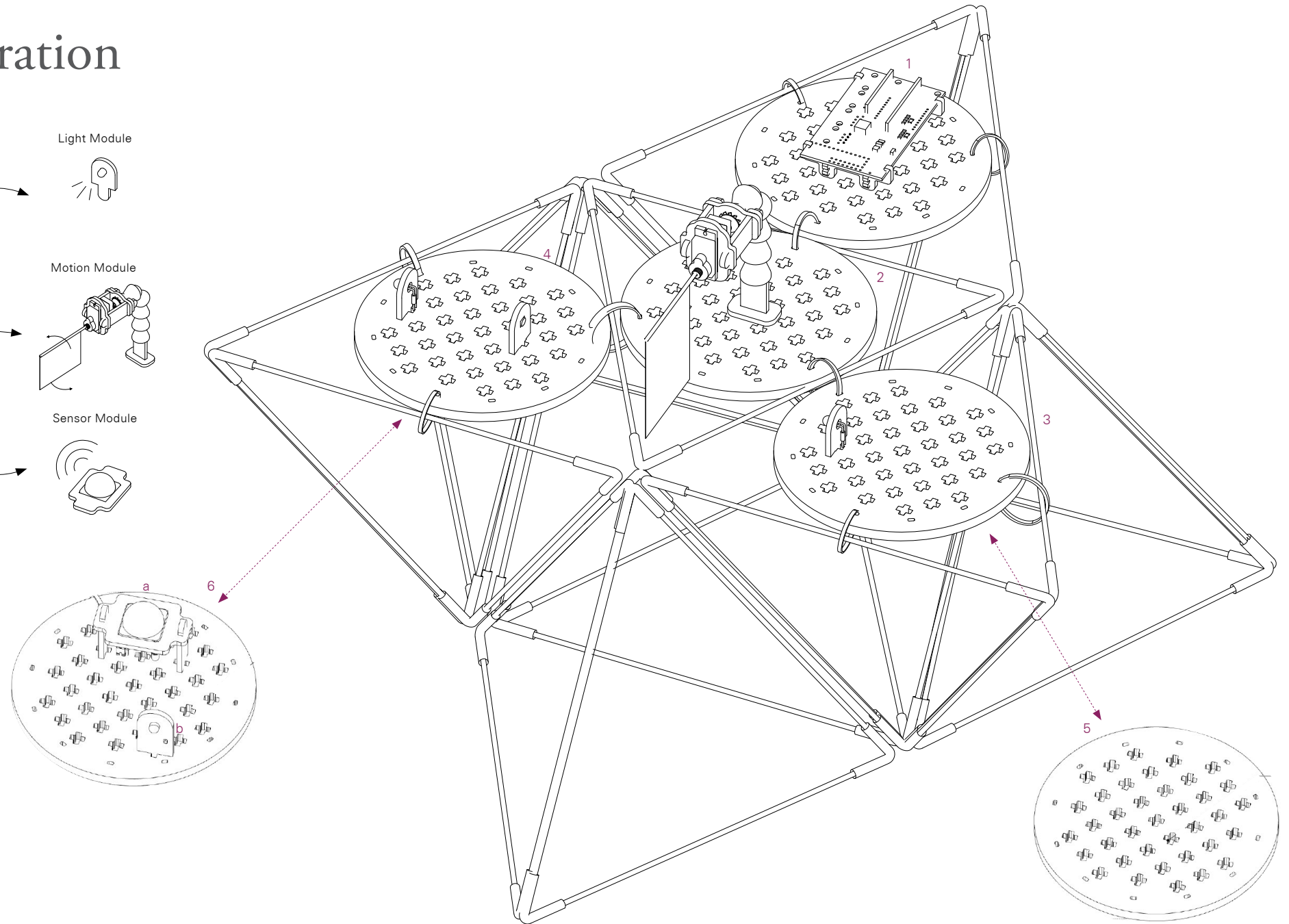



Truncated Tetrahedron Unit x1



Pyramid Unit x6

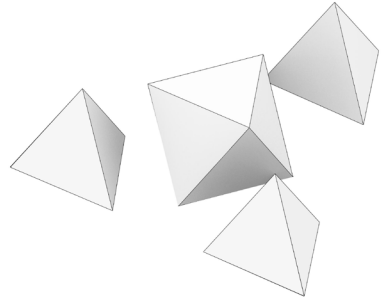

1

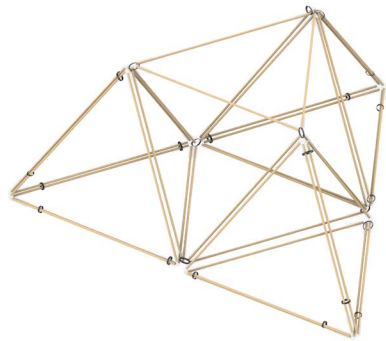
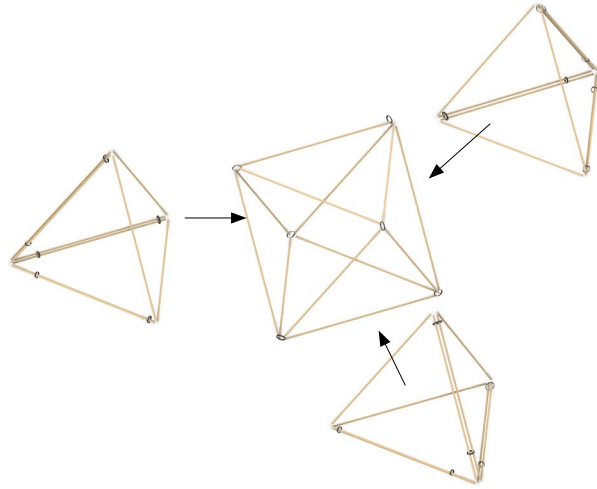

2

### Scaffold Assembly

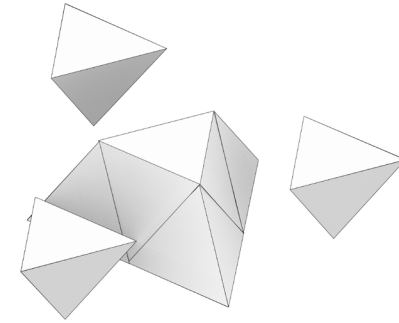

3

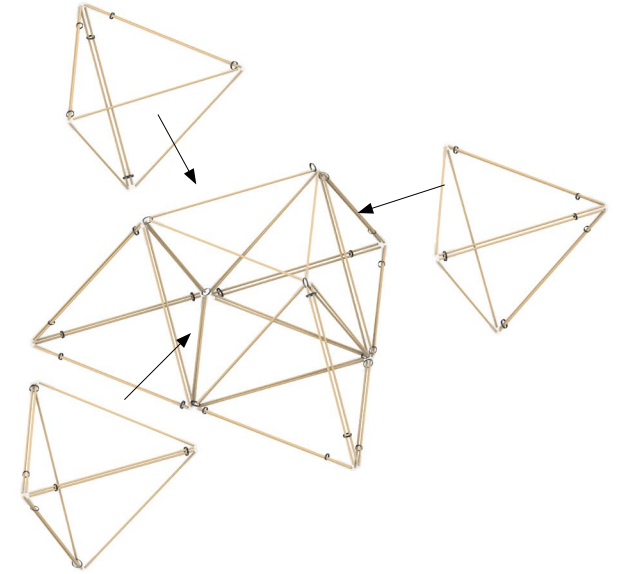

4

### Scaffold Assembly



## Light Detecting Assembly

- 1 Node Controller on Acrylic Sled
- 2 Flexible Arm on Acrylic Mount
- 3 Servo Bolted to Mounting Plate
- 4 Bamboo Truss Tower
- 5 Paper Sheet
- 6 LED on Peg Mount
- 7 Indicator LED on Peg Mount
- 8 Photoresistor on Peg Mount

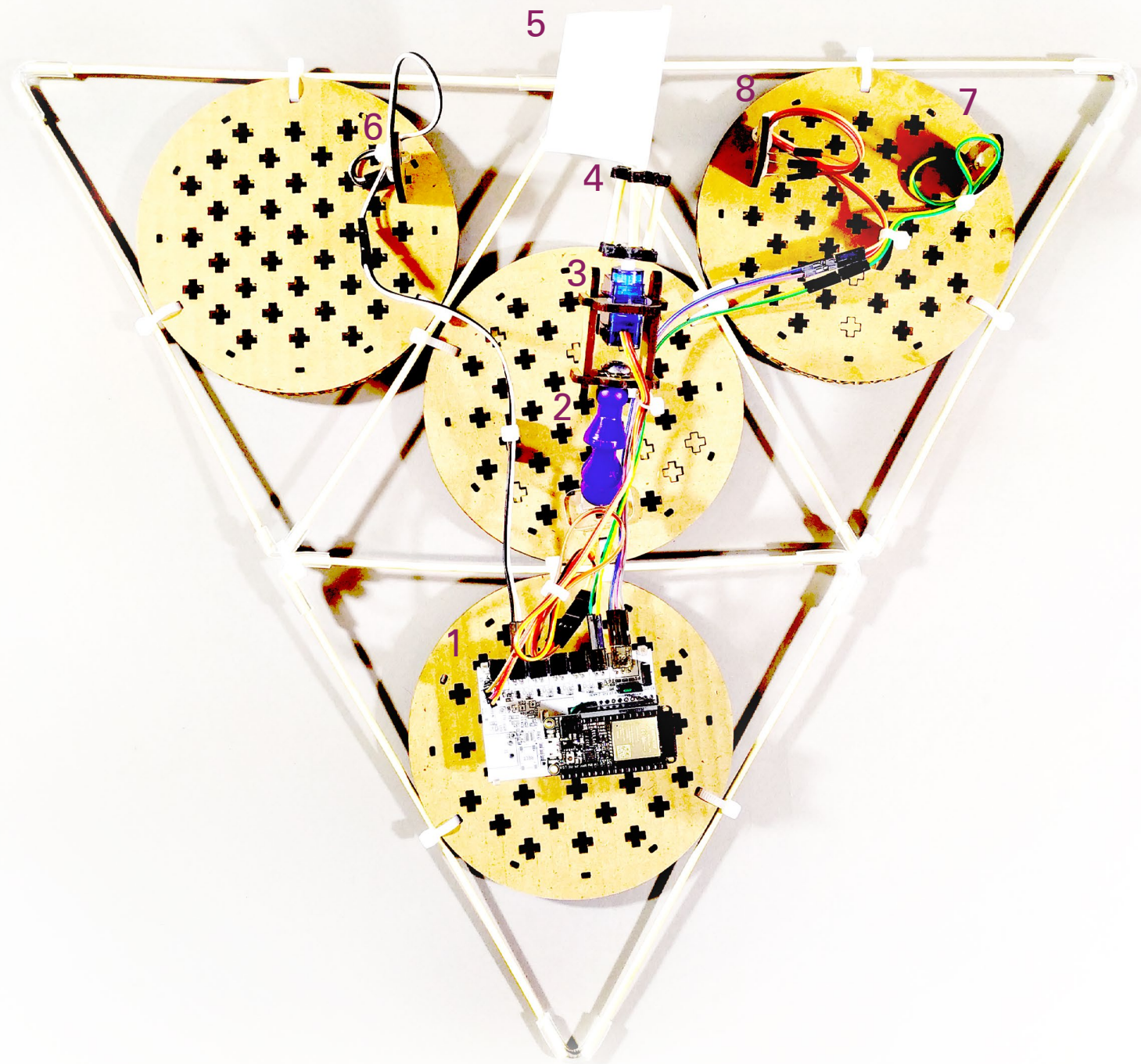

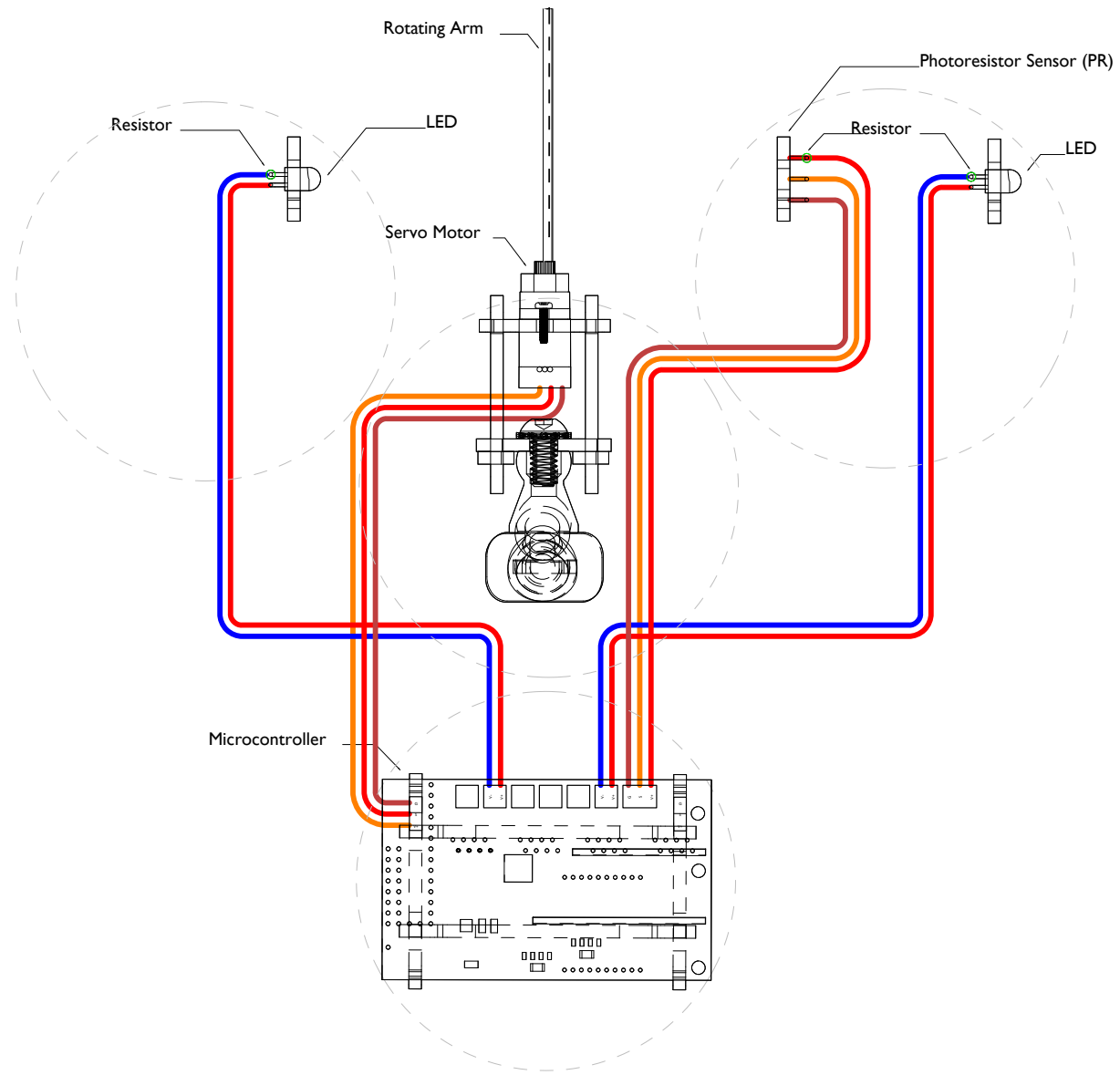

Light Detecting Assembly Cable Connections

V+ SIG GND V-

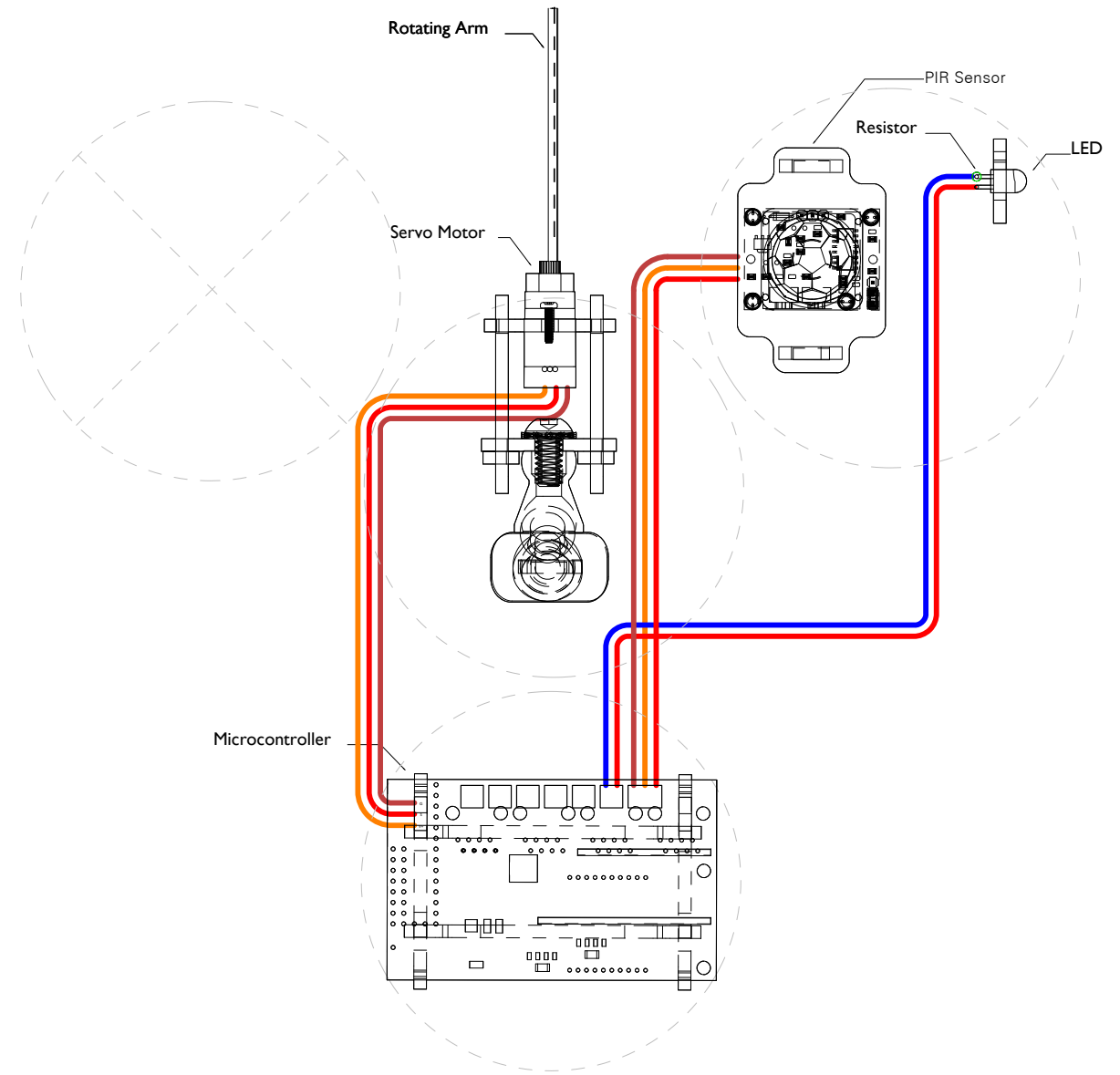

Variation: Motion Detecting Assembly Cable Connections

V+ SIG GND V-

# References

Bullivant, Lucy. *4dsocial: Interactive Design Environments*. London: AD/John Wiley & Sons, 2007.

Fox, Michael and Miles Kemp. *Interactive Architecture*. Princeton: Princeton Architectural Press, 2009.

“Living Architecture LIAR,” accessed February 2, 2022, <https://livingarchitecture-h2020.eu/>.

Nicholas Negroponte, *Being Digital*. New York: Vintage Books, 1995.

Oosterhuis, Kas and Xin Xia. *iA #1, Interactive Architecture*. Rotterdam: Episode Publishers, 2007.

Spiller, Neil. *Digital Architecture Now: A Global Survey of Emerging Talent*. London: Thames & Hudson, 2009.

# Open Access LASG Publications

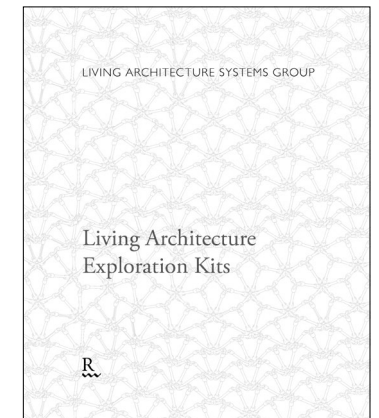
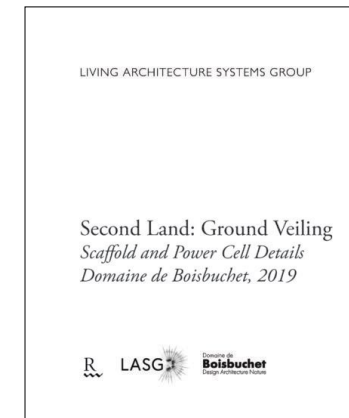
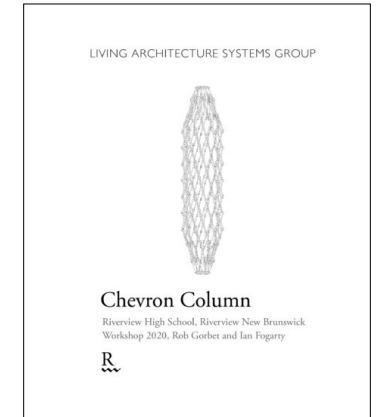
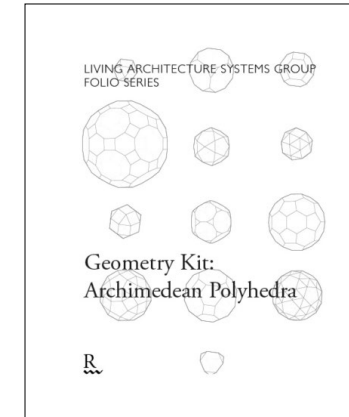



# Credits

## LASG Executive

Philip Beesley  
Timothy Boll  
Lisa Jiang  
Michael Lancaster  
Matt Gorbet  
Rob Gorbet  
Anne Paxton  
Rekha Ramachandran  
Alison Thompson

## LASG Design & Production

Alexandros Angelidis  
Jinchen Cai  
Adrian Chiu  
Kevan Cress  
Filipe Costa  
Nicolas Désilles  
Sebastián González Álvarez  
Simon Gorbet  
Ellie Hayden  
Isabella Ieraci  
Chris Kang  
Lucia Kempe  
Chiun Lee  
Glenn Lu  
Bianca Weeko Martin  
Mike Nopper  
Abida Rahman  
Severyn Romanskyy  
Stephen Ru  
Nathan Shakura